

**BASIC INFORMATION:**

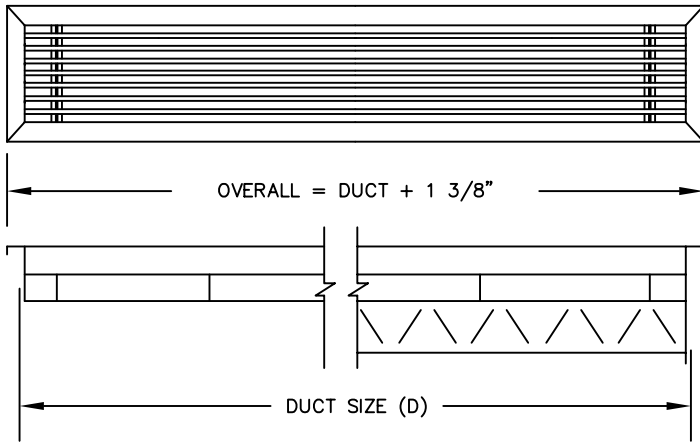

MODEL BGO GRILLE

MODEL BGD REGISTER

**MATERIAL:**

GRILLE: ALUMINUM  
DAMPER: STEEL

**FINISH:**

WHITE STANDARD  
MILL FINISH (OPTIONAL)

**SIZES:**

- HEIGHT: 1-1/2" MINIMUM, 22" MAXIMUM
- WIDTH: 12" MINIMUM, 100" MAXIMUM
- NECK SIZE: LISTED SIZE - 1/2"

**MODELS AVAILABLE:**

**GRILLE MODELS:**

- BGO/BGOH 480 (0° DEFLECTION)
- BGO/BGOH 481 (15° DEFLECTION)
- BGO/BGOH 580 (0° DEFLECTION)
- BGO/BGOH 581 (15° DEFLECTION)

**REGISTER MODELS:**

- BGD/BGDH 480 (0° DEFLECTION)
- BGD/BGDH 481 (15° DEFLECTION)
- BGD/BGDH 580 (0° DEFLECTION)
- BGD/BGDH 581 (15° DEFLECTION)

**BORDERS:**

STANDARD DUTY

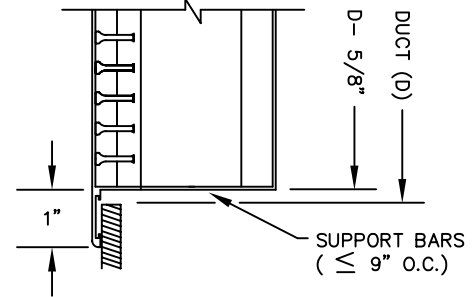

HEAVY DUTY

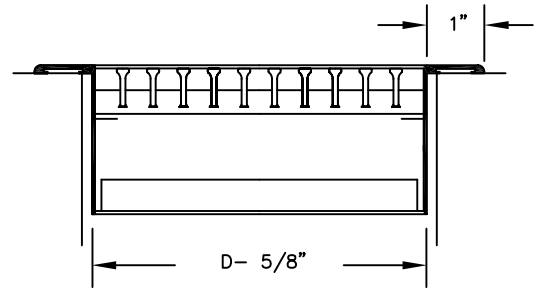

ACCESS DOOR OPTION

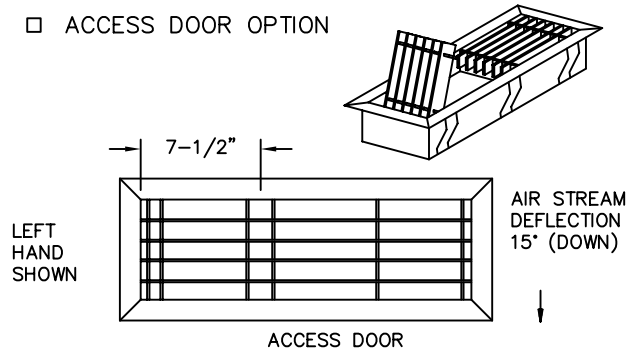

**AVAILABLE CORE STYLES:**

480

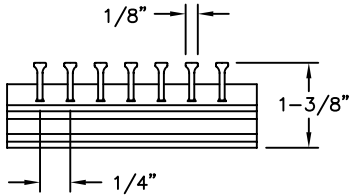

481

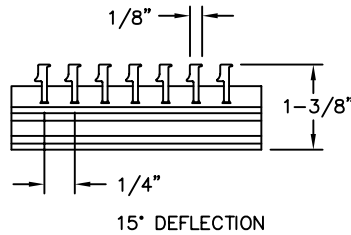

580

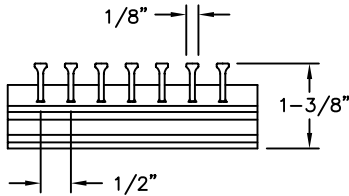

581

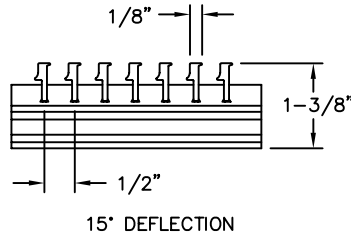

**FASTENING:**

A: COUNTERSUNK SCREW



FOR CEILING, WALL, SILL & FLOOR APPLICATION.

B: SPRING CLIP

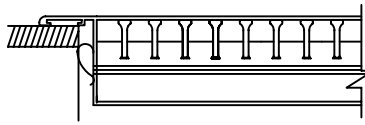

FOR SILL APPLICATION ONLY, NOT TO BE USED FOR CEILING OR WALL INSTALLATION.

C: CONCEALED BRACKET

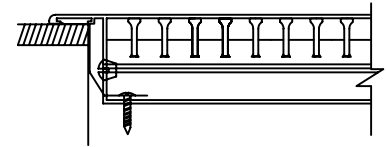

FOR CEILING, WALL, SILL & FLOOR APPLICATION.

**NOTE:** ALL DRAWINGS SUBJECT TO CHANGE WITHOUT PRIOR NOTICE.

TITLE:

BG/BGH (480/580 SERIES)

LINEAR BAR TYPE  
GRILLES/REGISTERS

NOTE: ALL DRAWINGS SUBJECT TO CHANGE WITHOUT PRIOR NOTICE.



**Grille tech inc.**

DRN BY: AV

DATE: 10/10/00

SCALE: NTS

DRAWING NO.

CKD BY: IV

DATE: 9/20/09

REV: C

BG