

BASIC INFORMATION:

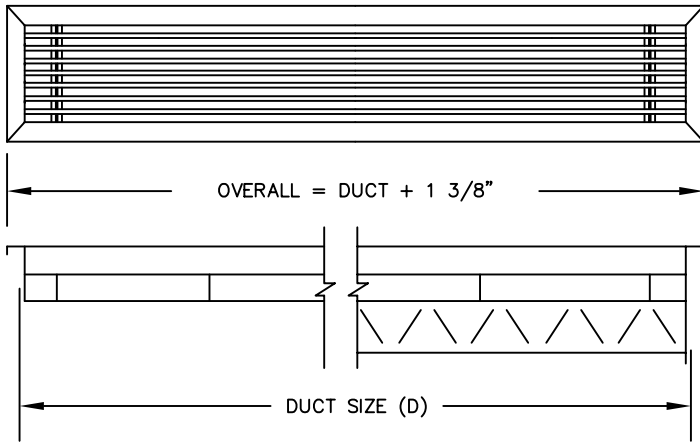

MODEL BGO GRILLE

MODEL BGD REGISTER

MATERIAL:

GRILLE: ALUMINUM
DAMPER: STEEL

FINISH:

WHITE STANDARD
MILL FINISH (OPTIONAL)

SIZES:

- HEIGHT: 1-1/2" MINIMUM, 22" MAXIMUM
- WIDTH: 12" MINIMUM, 100" MAXIMUM
- NECK SIZE: LISTED SIZE - 1/2"

MODELS AVAILABLE:

GRILLE MODELS:

- BGO/BGOH 540 (0° DEFLECTION)
- BGO/BGOH 541 (15° DEFLECTION)
- BGO/BGOH 54P (PENCIL PROOF)
- BGO/BGOH 543 (30° DEFLECTION)

REGISTER MODELS:

- BGD/BGDH 540 (0° DEFLECTION)
- BGD/BGDH 541 (15° DEFLECTION)
- BGD/BGDH 54P (PENCIL PROOF)
- BGD/BGDH 543 (30° DEFLECTION)

BORDERS:

STANDARD DUTY

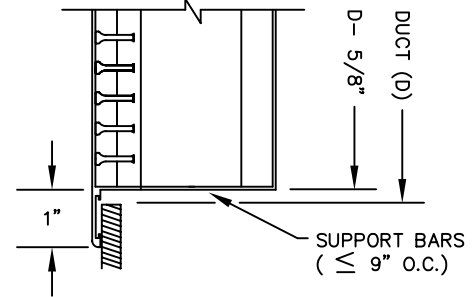

HEAVY DUTY

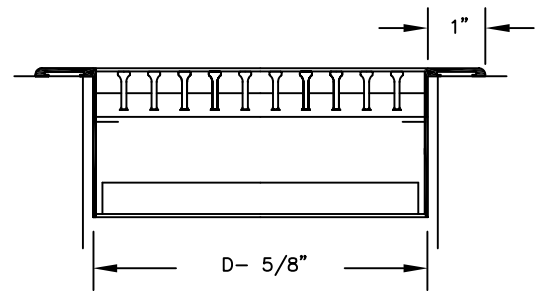

ACCESS DOOR OPTION

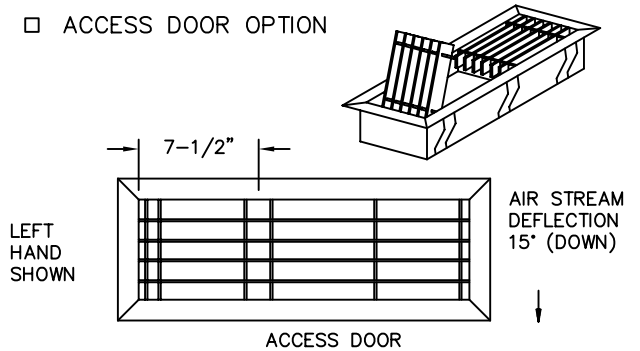

AVAILABLE CORE STYLES:

540

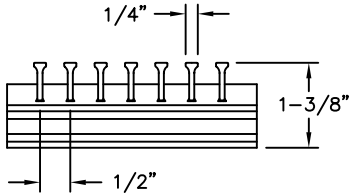

543

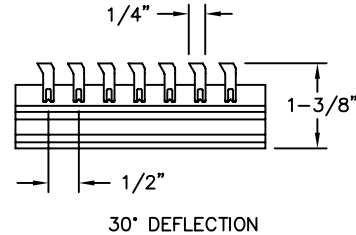

541

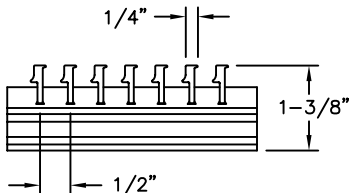

54P

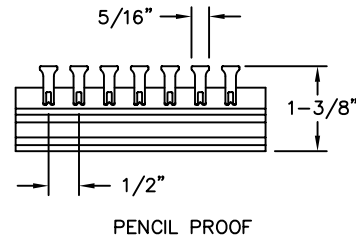

FASTENING:

A: COUNTERSUNK SCREW



FOR CEILING, WALL, SILL & FLOOR APPLICATION.

B: SPRING CLIP

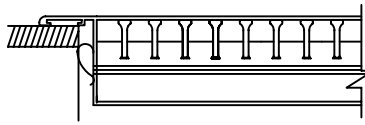

FOR SILL APPLICATION ONLY, NOT TO BE USED FOR CEILING OR WALL INSTALLATION.

C: CONCEALED BRACKET

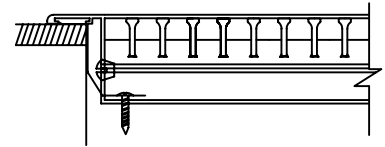

FOR CEILING, WALL, SILL & FLOOR APPLICATION.

NOTE: ALL DRAWINGS SUBJECT TO CHANGE WITHOUT PRIOR NOTICE.

TITLE:

BG/BGH (540 SERIES)

LINEAR BAR TYPE
GRILLES/REGISTERS

NOTE: ALL DRAWINGS SUBJECT TO CHANGE WITHOUT PRIOR NOTICE.



Grille tech inc.

DRN BY: AV

DATE: 10/10/00

SCALE: NTS

DRAWING NO.

BG540

CKD BY: IV

DATE: 9/20/09

REV: C